



ESSE
WOOD STOVES



QUALITY BRITISH ENGINEERING

— AND TIMELESS CLASSIC DESIGN —

ESSE continues to be a pioneer of clean burning, energy efficient heating and cooking stove design. Made in Britain since 1854, ESSE stoves have used the proven principle of heat storage to combine welcoming background warmth with dependable cooking performance.

Our beautifully hand crafted stoves are the choice of credited chefs and hosts worldwide for lavish dining and entertaining. Florence Nightingale would use no other brand at her field hospital in Balaclava, while Sir Ernest Shackleton relied on an ESSE stove during his Antarctic expeditions.

A wood-fired ESSE stove creates a focal point at the heart of the kitchen, and the heat from the stove fills the entire room with radiant, welcoming warmth.

Firebox and flue controls give an impressive level of temperature adjustment and a generous hotplate features graduated temperature zone for the perfect rolling boil to a gentle melt.

ESSE's deep, heat-retaining ovens provide a stable and even temperature, so dishes don't need to be turned during cooking.

ESSE has pioneered the development of clean-burning, low emission stoves for over 160 years and each model extracts every last calorie of heat from the wood, emitting minimal smoke and leaving only a tiny amount of ash.

Being a slow combustion wood stove means you can turn down the stove of an evening, and get it back up and running without fuss the next morning.

And when it comes to reducing our carbon footprint, sustainably sourced seasoned firewood is one the most environmentally friendly fuels available.

EST 1854

IT'S ALL ABOUT THE COOKING



DIRECT TO HOB

Sizzle, steam, toast, braise, boil and fry.

An ESSE cast iron hotplate offers multiple cooking methods. A heavy based pan or griddle can be heated on the hob. Searing, chargrilling or toasting can take place directly on the hotplate, and the dome design of the ESSE bolster lids creates a steam environment, perfect for char-steaming.

Cast iron hotplates are graduated temperature surfaces with the most concentrated heat always centred above the firebox.



OVER EMBERS

Savour the exceptional flavours of wood fired cooking. The ESSE wood family of stoves include a removable rack for cooking over coals in your firebox.

The glass door allows sight of food during cooking.

You too can achieve that classic restaurant chargrill bar mark and smoky flavour on your food.



ROAST IN THE OVEN

Maximise the energy created by your wood fired stove. The ovens are designed deeper than they are wide to minimise heat loss upon opening the oven door. This creates the perfect surround heat baking or roasting environment.

Outside the oven door incorporates the beautiful ESSE thermo-dial. Giving you the knowledge of the temperature of your oven, without ever opening the door.

Variable shelf positions and the ability to cook directly on the oven floor grant further oven capacity and versatility.



Durable modern squared hob finish



Dishwasher safe, removable inner door panels



ESSE's iconic chromed bolster lids



Even deeper ovens with easier to clean trims

ECO FRIENDLY ENGINEERING

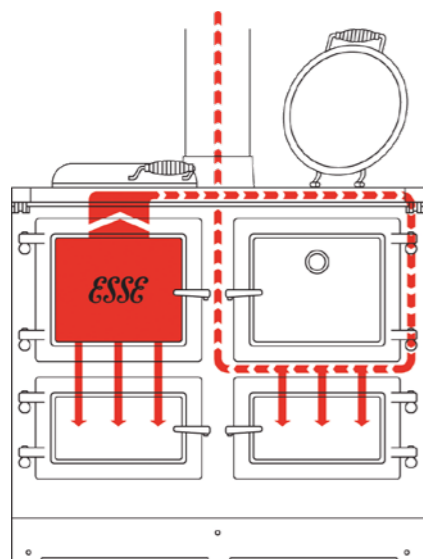

ESSE's unique draught means that you can direct the heat to surround the baking oven to cook evenly from all sides.

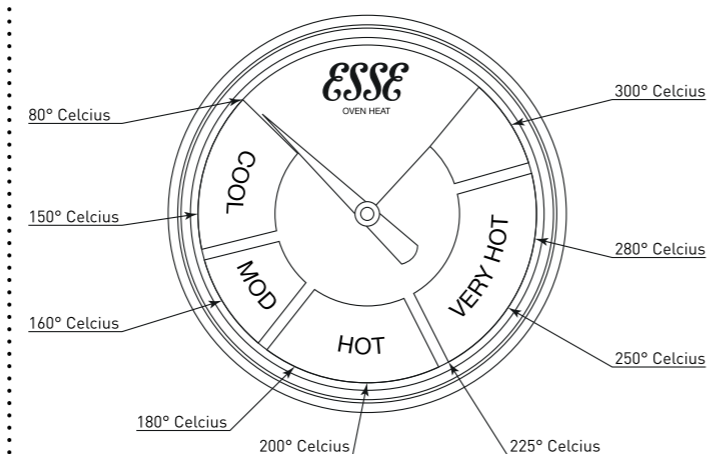

The temperature dial on the main oven door provides an indication of the oven temperature.



SINCE 1854

ESSE have been engineering wood stoves that burn clean and efficient since 1854. Nowadays this is achieved through ESSE's patented technology which reignites the smoke from your firebox, giving you more flame, more heat, and less emissions.

NO ORDINARY STOVES

Every stove is individually handmade by a Master Stove Maker at ESSE's factory in Barnoldswick, UK and include the latest in clean burning technology, proper slow combustion wood stoves with overnight burn.

BETTER FOR THE ENVIRONMENT

The combustion grid is made from metal plate alloys that sits directly over your firebox. As the grid is heated by the fire, the rising smoke from the firebox is reignited as it passes through the gaps between the plates.

In the ESSE 1000 W model, a catalytic combustor lies just below the hotplate and operates in a similar way. When the smoke from your fire is reignited, this turns directly into flame, giving you more heat and far less emissions with the same amount of wood, as well as those stunning flames ESSE is well known for.

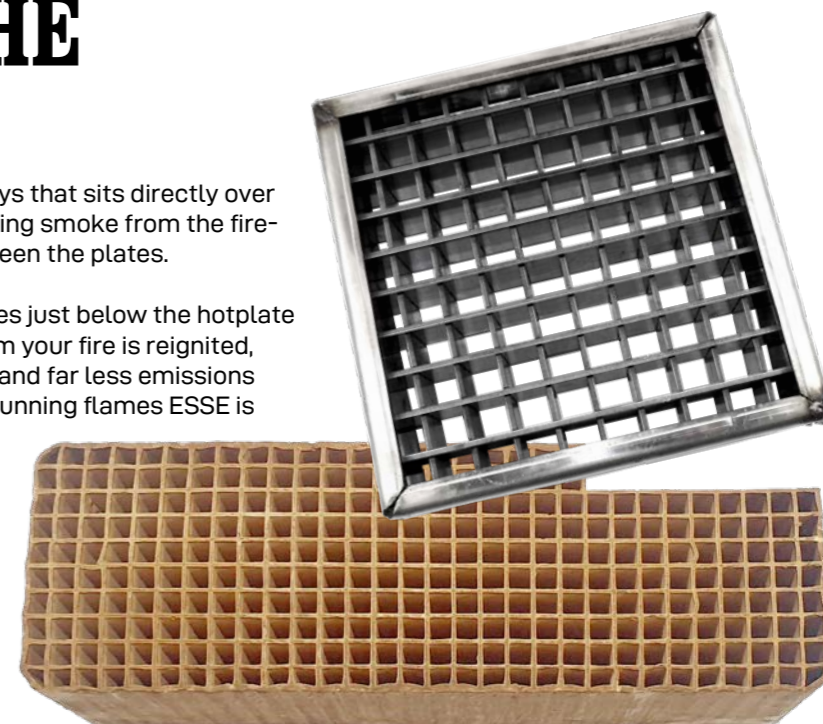

1000 W

THE NEXT GENERATION
WOOD STOVE



With three large ovens and a huge cast iron hotplate, this clever stove caters for all tastes.

The fourth door houses the glass fronted firebox; so you can check on your fire easily and add fuel without fuss. Fuelled by logs up to 360mm long, when loaded up before bedtime the dependable 1000 W will still be radiating warmth at breakfast.

Opening the firebox door on the left reveals a window through which you can gaze upon your fire that generates enough warmth to heat a room up to 60m².

The three true cooking ovens and large cast iron dog bone hotplate are all powered by the firebox.

The left of the hotplate directly above the fire can reach temperatures of up to 400°C. Simply slide your pans over to the right hand side of the hotplate to reduce temperatures from a rolling boil, across a steady simmer, to a gentle melt.

ESSE's deep, heat-retaining ovens provide a stable and even temperature, so dishes don't need to be turned during cooking.

With optional hot water, this is the wood stove for any home.

**1000 W
SPECIFICATIONS**

	WN	WD
OVEN CAPACITY		
TOP OVEN	50 LITRES	50 LITRES
BOTTOM OVENS	2 x 38 LITRES	2 x 38 LITRES
OVEN DIMENSIONS		
TOP OVEN	WIDTH 360mm, HEIGHT 305mm, DEPTH 520mm	
BOTTOM OVEN	WIDTH 360mm, HEIGHT 205mm, DEPTH 520mm	
HEAT SOURCE		
HOT PLATE CAPACITY	OVER 6 PANS	OVER 6 PANS
FLUE PIPE DIAMETER	6" (150mm)	6" (150mm)
MEAN BOILER OUTPUT	-	4kW
RADIANT OUTPUT TO ROOM (OPERATING RANGE)	3-5kW	3-5kW
MAX EFFICIENCY %	85	85
EMISSIONS (GRMS)	1	1
ADDITIONAL ROOM VENTS REQUIRED	-	1.75" Dia
CLEARANCES NON-COMBUSTIBLE MATERIALS FROM SIDE AND BACK 10MM; COMBUSTIBLE MATERIAL FROM SIDE 20MM FROM BACK 40MM	UNIT DIMENSIONS WIDTH 985MM HEIGHT 900MM DEPTH 670MM	

1000 W

WOOD STOVE

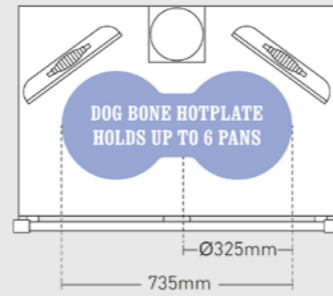

Large Dogbone Hotplate
Can fit multiple pans

ESSE's iconic chrome Bolster Lids

Oven Diverter

3+ Inner slide outs for
easy access cleaning

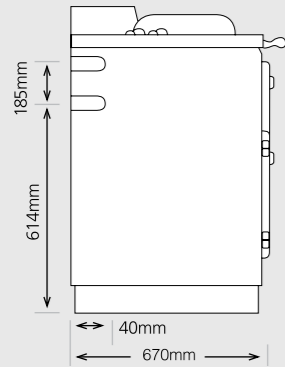

Inner glass door allows
heat into the room

Cook over embers with
the removable grill

Ignition control

Large 50ltr Baking Oven
(520mm deep)

Cook directly on the
base of the ovens

38ltr Grilling Oven
(520mm deep)

Removable oven
door liners
(dishwasher safe)

38ltr Slow Cook Oven
(520mm deep)

900mm

670mm

985mm



1000 HYBRID

HALF WOOD / HALF ELECTRIC
BEST OF BOTH



1/2 Wood, 1/2 Electric... The best of both worlds: Convenience and control of electric power with the cosy glow of a real fire. When your head wants the ease and convenience of electric power, but your heart still yearns for a real fire, ESSE has the answer.

Opening the beautiful firebox door on the LEFT reveals a window through which you can gaze upon a real WOOD fire that generates enough warmth to heat a room up to 60m².

Add a hot water jacket and generate 4kW of domestic hot water.

Behind the lower left door is an oven which derives its heat from the firebox for the rustic wood-fired roasting and baking performance.

The firebox also powers the large circular hotplate on the left of the hob, which can reach temperatures of up to 400°C and accommodate up to three pans; simply move to the outer edge of the hotplate to reduce the temperature from a rolling boil to a steady simmer.

The RIGHT side of the ESSE Hybrid is an all-ELECTRIC affair, comprising two cooking ovens, a full-width grill and a generous hotplate. This delivers finger tip control and flexibility with the style and elegance of an ESSE.

The external control panel can be wall mounted or can stand on a worktop.

The ESSE Hybrid electric range cooker requires 1 x 15AMP plug socket and a six-inch flue.

1000 H SPECIFICATIONS

	WN	WD
OVEN CAPACITY		
TOP OVEN	50 LITRES	50 LITRES
BOTTOM OVENS	2 x 38 LITRES	2 x 38 LITRES
OVEN DIMENSIONS		
TOP OVEN	WIDTH 360mm, HEIGHT 305mm, DEPTH 520mm	
BOTTOM OVEN	WIDTH 360mm, HEIGHT 205mm, DEPTH 520mm	
HEAT SOURCE		
HOT PLATE CAPACITY	OVER 6 PANS	OVER 6 PANS
FLUE PIPE DIAMETER	6" (150mm)	6" (150mm)
MEAN BOILER OUTPUT	-	4kW
RADIANT OUTPUT TO ROOM (OPERATING RANGE)	3-5kW	3-5kW
MAX EFFICIENCY %	85	85
EMISSIONS (GRMS)	1	1
ADDITIONAL ROOM VENTS REQUIRED	-	1.75" Dia
CLEARANCES NON-COMBUSTIBLE MATERIALS FROM SIDE AND BACK 10MM; COMBUSTIBLE MATERIAL FROM SIDE 20MM FROM BACK 40MM	UNIT DIMENSIONS WIDTH 985MM HEIGHT 900MM DEPTH 670MM	

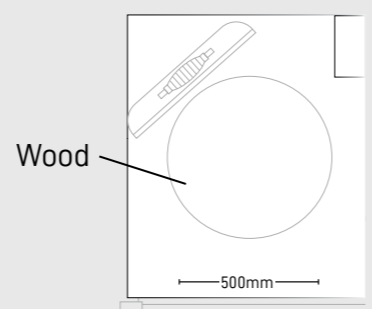
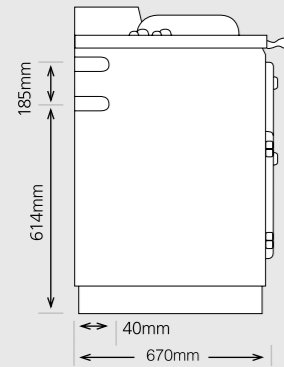

Large Circular Cast Hotplate

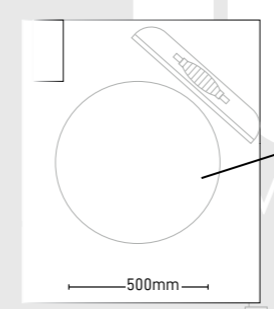

Large Circular Thermal Mass Hotplate

ESSE's iconic chrome Bolster Lids



Electric Control Panel



THE

IRONHEART FAMILY

The Ironheart family is our flagship range: encapsulating everything we know about cooking and heating into a beautiful simple range of stoves.

These versatile wood fired stoves offer a large, clear view of the flames in the firebox and provide a dependable source of heat and sustenance.

Its timeless design and simple styling reflect a state of the art piece of quality British engineering incorporating more than 160 years of ESSE cooking stove design and innovation.

Hand-made in Britain by a team of dedicated craftsmen with decades of experience, Ironheart stoves combine tradition and practicality. The durable exterior conceals super-efficient clean-burn technology that extracts maximum energy from the

combustion process, and stores heat for many hours after lighting.

Providing years of faithful service, our Ironheart stoves are engineered to exacting standards that ensure they can be relied upon to provide a constant source of warmth and comfort.

ESSE stoves have a loyal following around the world: from Alpine ski chalets to the Australian outback, the Ironheart's unique combination of durable British design and dependable performance adds a touch of style and luxury to even the most out of the way country cottages or rural retreats.

IRONHEART



BAKEHEART



WARMHEART



IRONHEART

THE HEART OF YOUR HOME



The iconic Ironheart has convection panels that radiate warmth to ensure it is the heart of your home.

The large firebox can burn logs of up to 500mm. You'll enjoy watching the flames leap and flicker through the large clear glass window, a picture-perfect view.

The Ironheart is equipped to bring out the very best in creative cooks – so no wonder it's become a firm favourite with head chefs

around the world.

The oven has a 47-litre capacity and you can also cook over coals in the firebox, while the 'dog-bone' cast iron hotplate will comfortably accommodate up to six pans.

An optional 'hostess shelf' has been designed to fit to the side of the Ironheart to extend the top and give an additional preparation space or will fit a standard, off the shelf, domino hotplate.

IRONHEART SPECIFICATIONS

	WN	WD
OVEN CAPACITY	47.8 LITRES	
OVEN DIMENSIONS	WIDTH 320mm, HEIGHT 340mm, DEPTH 440mm	
HOTPLATE	UP TO 6 PANS	
FLUE PIPE DIAMETER	6" (150mm)	
FEATURES		
OVERNIGHT BURNING SUITABLE FOR CONTINUOUS BURNING	✓	
OPTIONAL OUTSIDE AIR INTAKE	✓	
RADIANT OUTPUT TO ROOM (OPERATING RANGE)	6kW - 8kW	
LOG BURNING FIREBOX GRATE	OPTIONAL	
MAX EFFICIENCY %	81	
EMISSIONS	1.9	
HOT WATER JACKET	N/A	4kW
CLEARANCES NON-COMBUSTIBLE MATERIALS FROM SIDE AND BACK 25MM; COMBUSTIBLE MATERIAL FROM SIDE 160MM FROM BACK 200MM	UNIT DIMENSIONS WIDTH 900MM HEIGHT 900MM DEPTH 600MM	

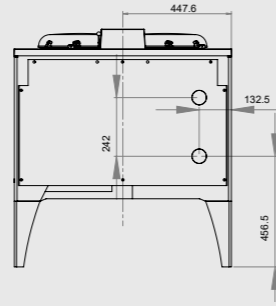

IRONHEART

WOOD STOVE

ESSE's iconic Bolster Lids

Flue damper

Large Dogbone Hotplate
Can fit multiple pans

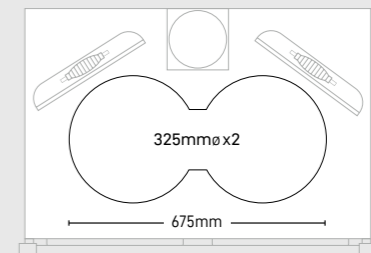

Secondary Air Control

Oven Diverter

Large 47.8ltr Oven
(440mm deep)

Cook directly over embers

Cook directly on the base of the oven

Glass Door

Primary Air Control

Ash Pan

Optional Outside Air

Easy access cleaning

Comes with ESSE's firebox fire screen



900mm

900mm

BAKEHEART

BAKERS BEST FRIEND



Using the same principles as our best-selling Ironheart, offering a clear view of the flames through the large glass door to the firebox, the wood fired Bakeheart provides ample heat to keep a cottage kitchen warm and toasty all night long with an extra long burn time.

ESSE's unique heat transfer stove technology efficiently channels heat from the firebox down into the 32-litre oven and hob.

Combine with a hot water jacket and the Bakeheart can also provide hot water while the hob and oven will cook a limitless range of wholesome and hearty dishes from warming casseroles to heavenly home-baked bread.

Designed to accommodate dry, seasoned logs of up to 360mm in length the Bakeheart can be installed pretty much anywhere to provide a reliable, 'off-grid' source of heat for extended periods.

Whether it's providing heat and hot water in a shack up in the mountains or wood fired pizzas on the verandah at the beach house, the Bakeheart can be counted on to deliver heat and sustenance, day in, day out.

BAKEHEART

WOOD STOVE

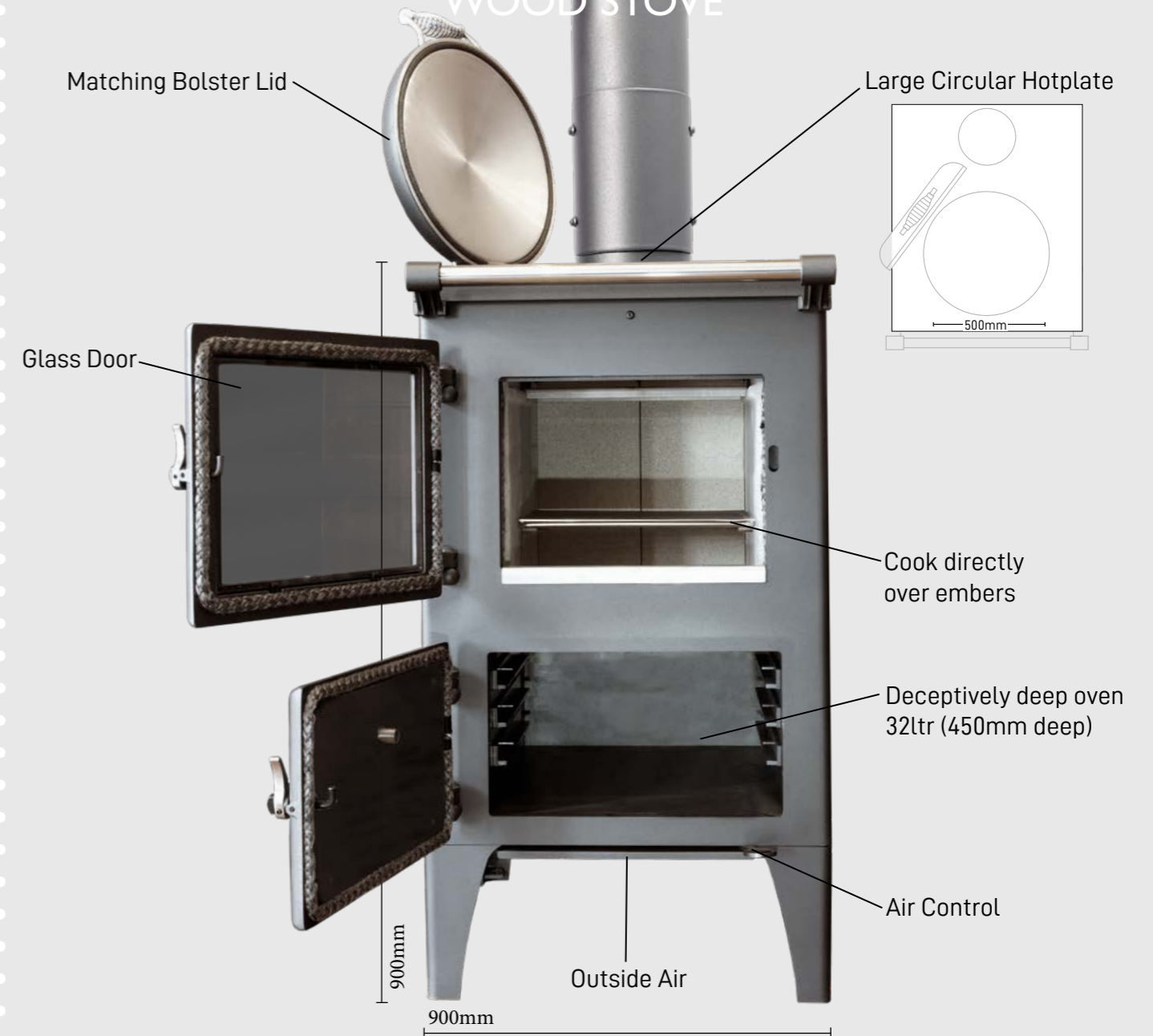

BAKEHEART SPECIFICATIONS

	WN	WD
OVEN CAPACITY		32 LITRES
OVEN DIMENSIONS	WIDTH 350mm, HEIGHT 200mm, DEPTH 450mm	
HOTPLATE		500mm
FLUE PIPE DIAMETER		6" (150mm)
FEATURES		
OVERNIGHT BURNING SUITABLE FOR CONTINUOUS BURNING		✓
OPTIONAL OUTSIDE AIR INTAKE		✓
MAX EFFICIENCY %	77	66
EMISSIONS		1.4
HOT WATER JACKET	N/A	2.8kW
CLEARANCES	UNIT DIMENSIONS	
NON-COMBUSTIBLE MATERIALS FROM SIDE AND BACK 25MM;	WIDTH 500MM HEIGHT 900MM	
COMBUSTIBLE MATERIAL FROM SIDE 130MM FROM BACK 150MM		



WARMHEART

STEAKS ON THE HOTPLATE OR
FISH IN THE FIREBOX

Whether it's providing heat and hot water in a remote mountain hut or chargrilled T-bones or fresh cooked fish after a day fishing on the lake, the Warmheart can be counted on to deliver consistent heat and sustenance, wherever and whenever you need it.

Designed to accommodate dry, seasoned logs of up to 360mm length, the Warmheart can be installed pretty much anywhere to provide a reliable, 'off-grid' source of heat over extended periods - no mains services required.

Combine with a hot water jacket and the 50m² Warmheart will also provide hot water while the hob can be used to boil a kettle, cook a casserole, or griddle a steak.



WARMHEART



WARMHEART SPECIFICATIONS

	WN	WD
HOTPLATE		500mm
FLUE PIPE DIAMETER		6" (150mm)
FEATURES		
OVERNIGHT BURNING SUITABLE FOR CONTINUOUS BURNING		✓
OPTIONAL OUTSIDE AIR INTAKE		✓
MAX EFFICIENCY %	77	64
EMISSIONS		1.5
HOT WATER JACKET	N/A	2.8kW
CLEARANCES NON-COMBUSTIBLE MATERIALS FROM SIDE AND BACK 25MM; COMBUSTIBLE MATERIAL FROM SIDE 350MM FROM BACK 125MM		
		UNIT DIMENSIONS WIDTH 500MM HEIGHT 700MM

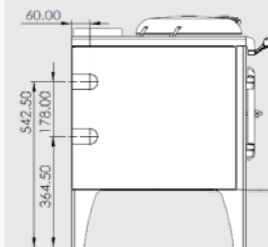

DELUXE model comes with ESSE's firebox fire screen



ESSE

ESSE has been hand-building range cookers and stoves since 1854 and our products are designed and built with a care and attention-to-detail that has helped us become the authority. That's why we feel ESSE should be showcased, sold and installed with the same diligence. We take great care in carefully selecting retailers that make up our 'ESSE Specialist' network.

ESSE are proud to invest in exclusive training for our ESSE Specialists and we keep them continually abreast of all product developments. We actively encourage our ESSE Specialists to carry as many 'live' models as possible in their showrooms, so that you can see them in action and ask as many questions as you like, before selecting an ESSE to suit your lifestyle. We also offer a full technical and after sales support service.

We actively support our hard working retailers wherever possible, and encourage customers to visit their local ESSE showrooms for the highest level of service.

ESSE and ESSE Australia offer a host of after sales service and technical support via our qualified retailers who each hold a wealth of knowledge and experience regarding the sale, installation and the operation of ESSE appliances.

2 Year Warranty

ESSE products purchased through an ESSE Specialist will automatically be covered by our 2 year warranty.

5 Year Warranty

If you purchased through an ESSE specialist and register your warranty with ESSE within 1 month of installation, we will extend your warranty for a further 3 years to a total of 5 years.

See website for Terms and Conditions



Beautifully

**HAND-CRAFTED
IN  BRITAIN**



Contact us

Got a question for us about ESSE?
Please get in touch with your closest reseller

pivotstove.com.au

ESSE